



XDVD8181

INSTALLATION/OWNER'S MANUAL

DVD Multimedia Receiver with 7" Touch Screen Display



Safety Note:

The DVD video display of the in-dash unit will not operate while the vehicle is moving. This is a safety feature to prevent driver distraction. In-dash DVD video functions will only operate when vehicle is in Park and the parking brake is engaged. It is illegal in most states for the driver to view video while the vehicle is in motion.



Table of Contents

	Page
DVD Region Management	2
Safety Information/Precautions	3
Preparation/Mounting/Wiring	4-7
Control Locations - Monitor Close	8-9
Control Locations - Monitor Open	10-11
Control Locations - Remote	12-13
General Operation	14-19
System Setup Menu	20-21
Setting the Clock	22
Anti-theft Code	23
System Screen Setup	24-27
AM/FM Tuner Operation	28-29
DVD Operation Menu	30-37
DVD Setup	38-40
SVCD Operation	41
CD Operation	42-43
MP3/WMA Operation	44-45
Media Compatibility	46-47
Troubleshooting	48
Warranty	49
Notes	50
Specifications	51

DVD Region Management

Some DVD discs can be played only in certain playback modes according to the intentions of the software. As the XDVD8181 plays discs according to their intentions, some functions may not work as intended. Please be sure to read the instructions provided with each disc. This player has been designed to play back DVD software that has been encoded for specific region areas. It cannot play back DVD software encoded for other region areas than the region areas for which it has been designed.

The XDVD8181 will play discs labeled "Region 1" or "All".

DVD region codes:

- 1 - USA, Canada
- 2 - Japan, Europe, South Africa, Middle East
- 3 - Rep. of Korea, Taiwan, Hong Kong, Parts of Southeast Asia
- 4 - Australia, New Zealand, Mexico, South America
- 5 - Eastern Europe, Russia, India, Africa
- 6 - China





Safety Information

Please read all instructions carefully before attempting to install or operate.

Due to its technical nature, it is highly recommended that your DUAL XDVD8181 is installed by a professional installer or an authorized dealer. This product is only for use in vehicles with 12VDC negative ground only.

Safety Notes:

The DVD video display of the in-dash unit will not operate while the vehicle is moving. This is a safety feature to prevent driver distraction. In-dash DVD video functions will only operate when vehicle is in Park and the parking brake is engaged. It is illegal in most states for the driver to view video while the vehicle is in motion.

To prevent damage or injury:

1. Make sure to ground the unit securely to the vehicle chassis ground.
2. Do not remove the top or bottom covers of the unit.
3. Do not install the unit in a spot exposed to direct sunlight or excessive heat or the possibility of water splashing.
4. Do not subject the unit to excessive shock.
5. When replacing a fuse, only use a new one with the prescribed rating. Using a fuse with the wrong rating may cause the unit to malfunction.
6. To prevent short circuits when replacing a fuse, disconnect the wiring harness first.
7. Use only the provided hardware and wire harness.
8. You cannot view video while the vehicle is moving. Find a safe place to park and engage the parking brake.
9. If you experience problems during installation, consult your nearest DUAL dealer.
10. If the unit malfunctions, reset the unit as described on page 11 first. If the problem still persists, consult your nearest DUAL dealer or call tech assistance @ 1-866-382-5476.
11. To clean the monitor, wipe only with a dry silicone cloth or soft cloth. Do not use a stiff cloth, or volatile solvents such as paint thinner and alcohol. They can scratch the surface of the panel and/or remove the printing.
12. When the temperature of the unit falls (as in winter), the liquid crystal inside the screen will become darker than usual. Normal brightness will return after using the monitor for a while.

Additional notes:

1. When extending the ignition, battery or ground cables, make sure to use automotive-grade cables or other cables with an area of 0.75mm (AWG 18) or more to prevent voltage drops.
2. Do not touch the liquid crystal fluid if the LCD is damaged or broken. The liquid crystal fluid may be hazardous to your health or fatal. If the liquid crystal fluid from the LCD contacts your body or clothing, wash it off with soap immediately.

This device complies with part 15 of the FCC rules and regulations.

Operation is subject to the following two conditions:

- 1) This device may not cause harmful interference, and
- 2) This device must accept any interference received, including interference that may cause undesired operation.



XDVD8181 INSTALLATION

Preparation

Please read entire manual before installation.

Before You Start

- Disconnect negative battery terminal. Consult a qualified technician for instructions.
- Avoid installing the unit where it would be subject to high temperatures, such as from direct sunlight, or where it would be subject to dust, dirt or excessive vibration.

Getting Started

- Remove the four #1 phillips head screws from each corner, and slide the unit out of the mounting sleeve.
- Install mounting sleeve into opening, bending tabs to secure.
- Connect wiring harness and antenna as shown on pages 5-6. Consult a qualified technician if you are unsure.
- Certain vehicles may require an installation kit and/or wiring harness adapter (sold separately).
- Test for correct operation and slide unit into mounting sleeve, secure with #1 phillips screws as removed in step 1.
- Snap trim ring into place.
- Mount the iplug™ adapter to any smooth clean surface using the supplied double-sided tape or #2 x 3/8" Phillips head screws.

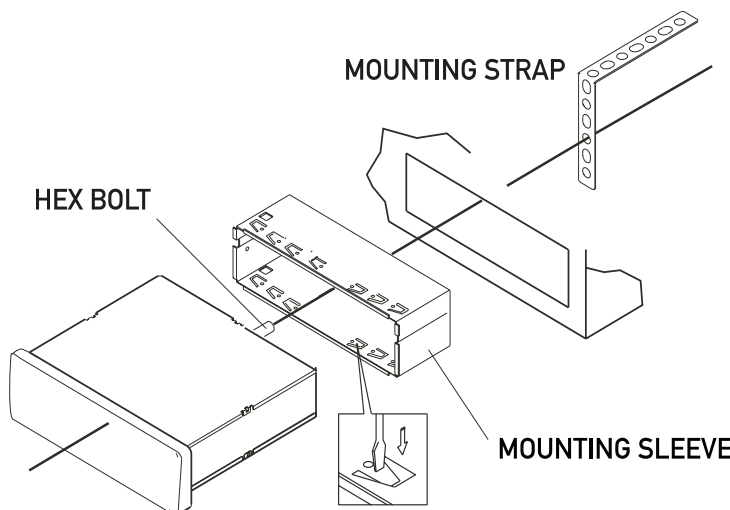
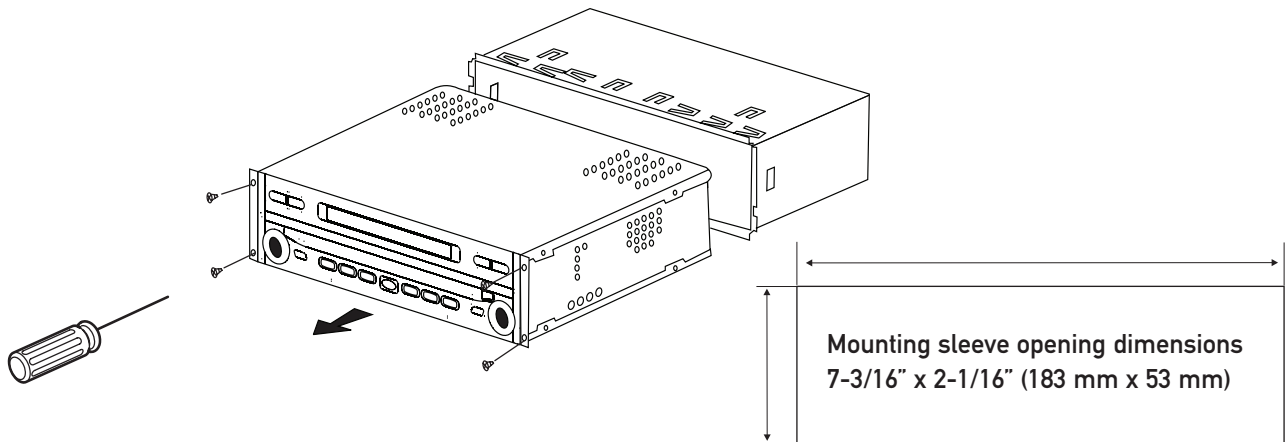

TYPICAL FRONT-LOAD DIN MOUNTING METHOD

Expanded Wiring Diagram - Inputs/Outputs

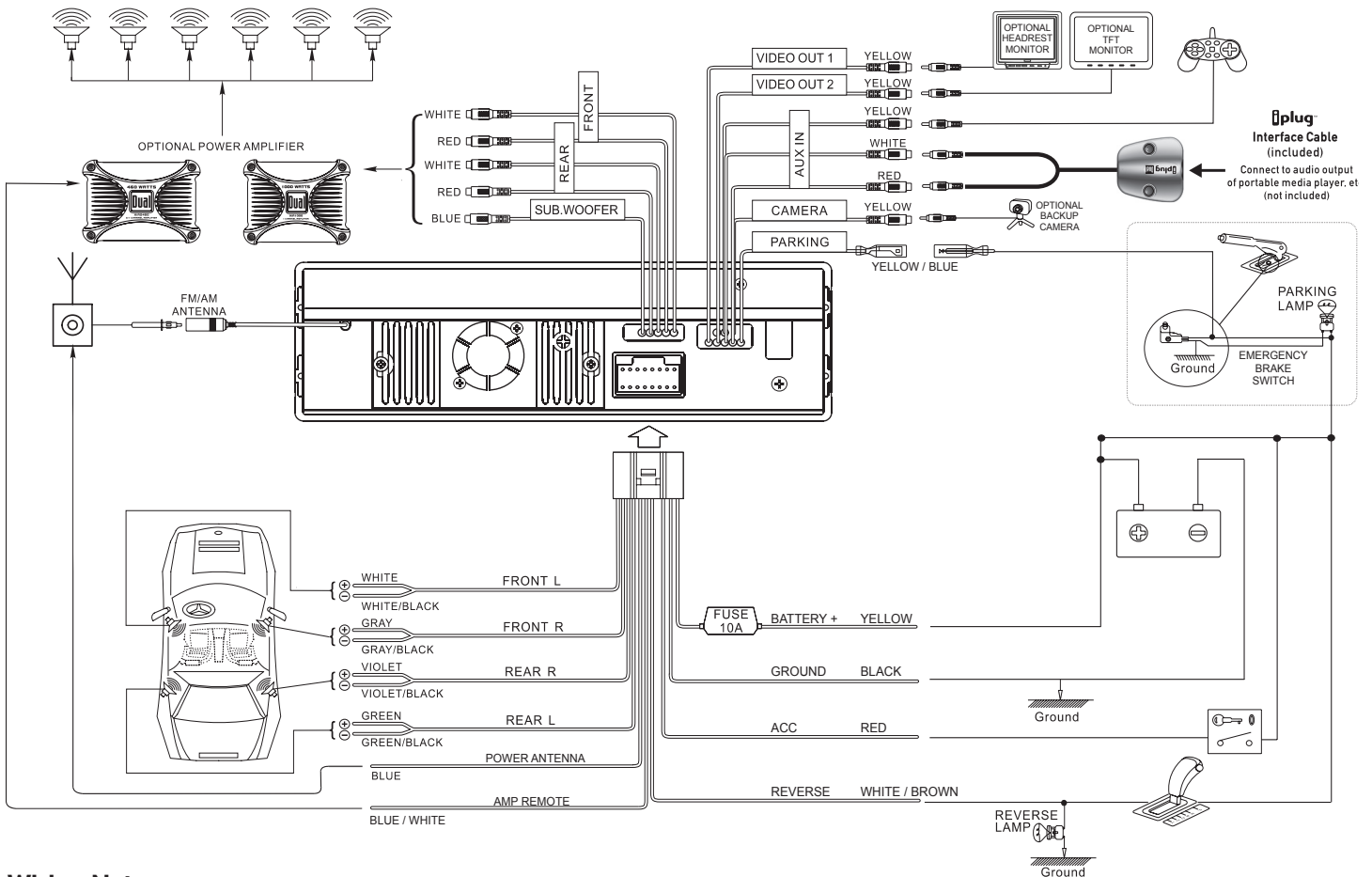

Wiring Notes:

Subwoofer output

The **SUBWOOFER** audio output (Blue RCA) is active in all audio modes and must be connected to an external amplifier.

Rear view camera

A rear view camera (not included) can be used with **CAMERA** input.

NEED HELP??

Call our Technical Service Hotline, 1-866-382-5476

Safety Note:

The DVD video display of the in-dash unit will not operate while the vehicle is moving. This is a safety feature to prevent driver distraction. In-dash DVD video functions will only operate when vehicle is in Park and the parking brake is engaged. It is illegal in most states for the driver to view video while the vehicle is in motion. Altering or defeating this safety feature is a violation of law and is prohibited.

Wiring Diagram - Optional A/V Connections

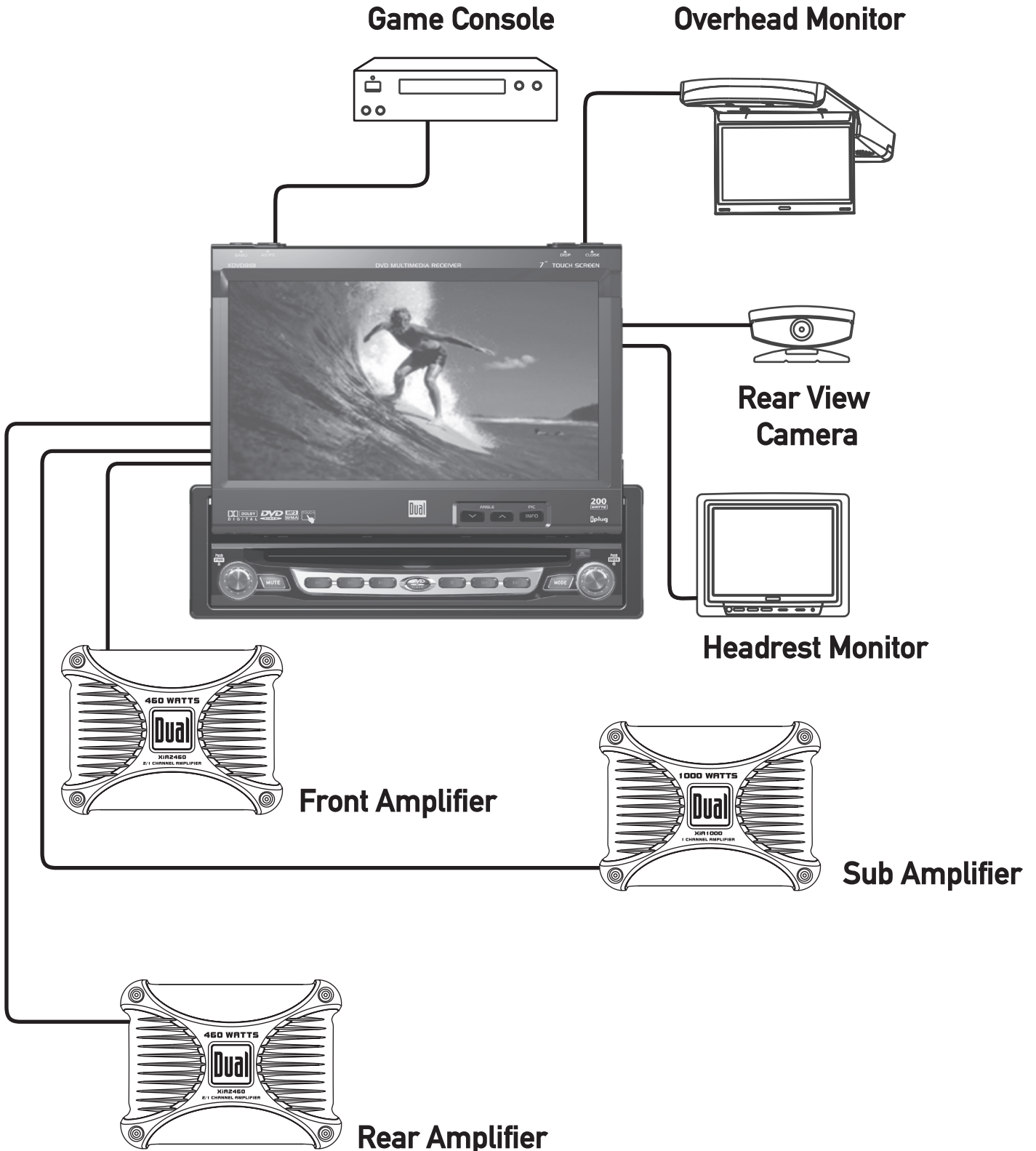

IR Remote Preparation

To first use the IR Remote control, you must first pull the battery insulation tape out

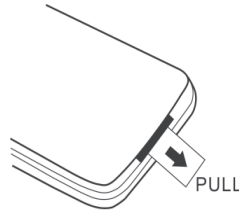

NOTE:

- Remove the battery if the IR Remote will not be used for a month or longer
- Remove and dispose of battery properly

Insert / Replacing the Battery:

Remove the battery holder

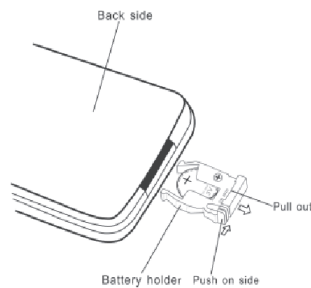

Remove the battery from the battery holder

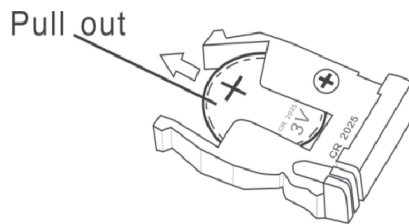

Install the new battery
Make sure to keep the (+) side up

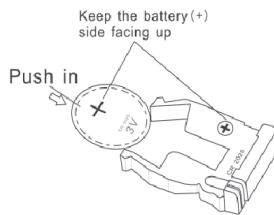

Insert the battery holder

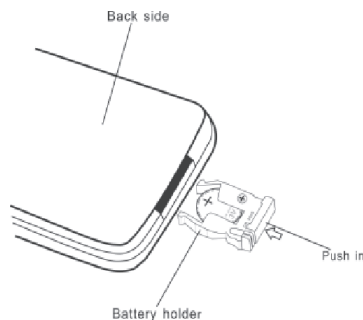

CAUTION!!!

- Do not store battery with metallic objects or materials

Control Locations - Monitor Closed

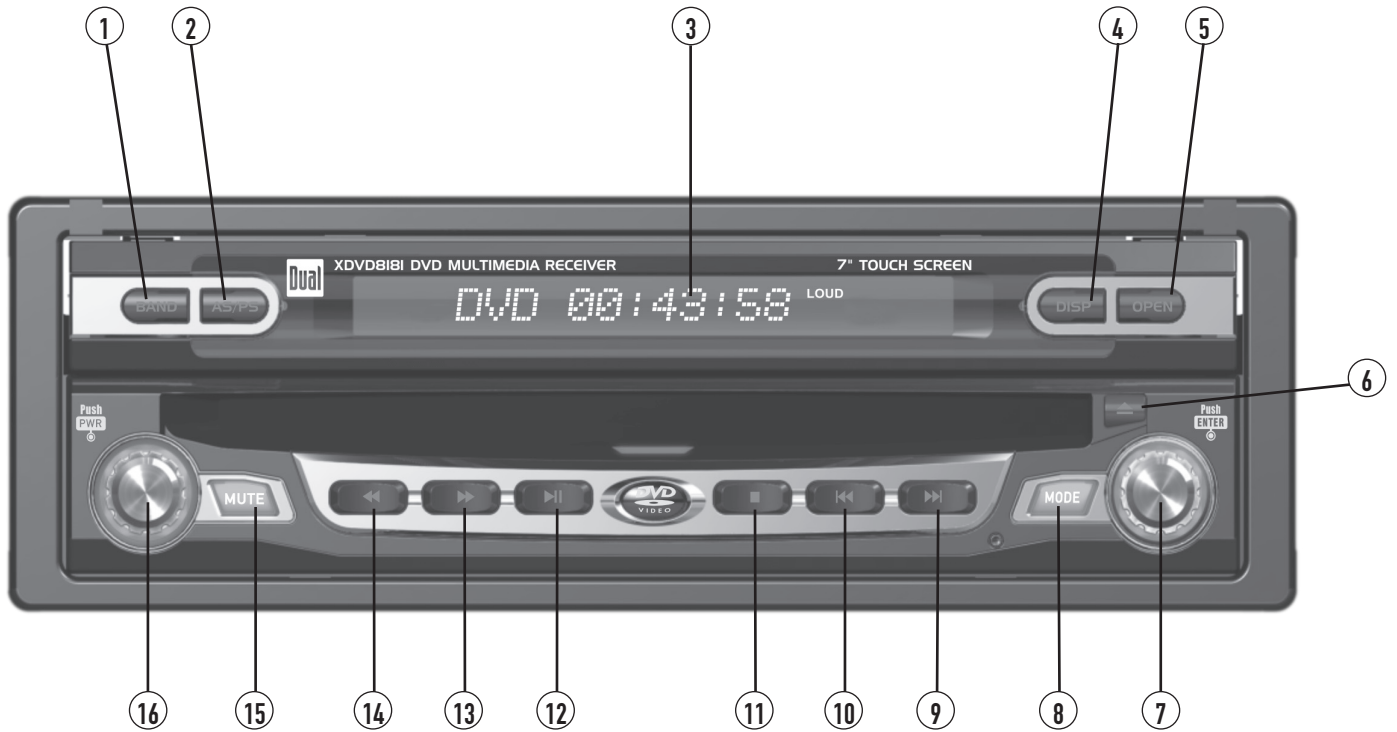

- | | |
|--------------------------|----------------------|
| ① Band | ⑨ Chapter/Track Up |
| ② Auto Store/Preset Scan | ⑩ Chapter/Track Down |
| ③ Secondary LCD | ⑪ Stop |
| ④ Display | ⑫ Play/Pause |
| ⑤ Open/Close Monitor | ⑬ Fast Forward |
| ⑥ Eject | ⑭ Fast Reverse |
| ⑦ Rotary Encoder / Enter | ⑮ Mute |
| ⑧ Mode | ⑯ Power/Volume |

Monitor Notes:

- This model incorporates a motorized moving monitor. Before final installation, make sure the monitor will not obstruct the dash, shifter or any other controls.
- Upon installation, do not attempt to move the monitor up/down by hand. Use the **ANGLE ▲/▼** and **OPEN** buttons on the front panel only.
- The unit will stop if it encounters any obstacles during the open/close sequence. If this occurs, remove the obstacle and press **OPEN** again to resume the monitor open/close sequence.

Control Functions - Monitor Closed

BAND	Press BAND to increment from FM1, FM2, FM3, AM1⇒ FM1.
AS/PS (Auto Store /Preset Scan)	Press AS/PS for 1 sec to start station PRESET SCAN function, Press AS/PS for 2 secs to start AUTO STORE station preset function in current BAND .
SECONDARY LCD	Additional LCD for system information while monitor is closed.
DISP	Press the DISP button to display CLOCK information on the secondary LCD screen when the monitor is closed.
OPEN	Press OPEN to open or close the monitor. The unit will emit 1 confirmation beep upon opening, 3 beeps when closing. Be careful not to not touch or obstruct the monitor movement during the open/close sequence, or permanent damage could occur.
EJECT	Press once for DISC ejection.
ROTARY	Press to access MAIN menu, rotate clockwise/counter clockwise to select desired item and press once to ENTER .
MODE	Press once to incrementally select desired source.
TRACK UP	Selects the next chapter/track for playback.
TRACK DOWN	Selects the previous chapter/track for playback.
STOP	Stop playback of DVD / CD / MP3 / .
PLAY/PAUSE	Press once for PAUSE , press again for PLAY .
FAST FORWARD	Fast forward the disc content.
FAST REVERSE	Fast reverse the disc content.
MUTE	Press once to MUTE audio, press again to return audio, an icon indicator will flash on the TFT monitor.
POWER ON/OFF	Press Volume knob for 1sec to turn the unit on, the unit will beep 2 times. Press and hold POWER for more than 2secs, unit will beep 3 time, then turn off. NOTE: EJECT will still function even if POWER is off.
VOLUME	Rotate clockwise/counter clockwise for desired VOLUME level, press once to access the AUDIO SETUP MENU .

Control Locations - Monitor Open



- ① Disc-in indicator - Red = Disc inserted, Blue = No disc .
- ② ANGLE ▼ - Press to decrease the monitor view angle.
- ③ ANGLE ▲ - Press to increase the monitor view angle.
- ④ INFO - Press to select system **INFO** and press and hold for **BRIGHTNESS**.
- ⑤ Press to **RESET** system.

Safety Notes:

The DVD video display of the in-dash unit will not operate while the vehicle is moving. This is a safety feature to prevent driver distraction. In-dash DVD video functions will only operate when vehicle is in Park and the parking brake is engaged. It is illegal in most states for the driver to view video while the vehicle is in motion.

Control Functions - Monitor Open

Disc-in indicator

Blue = No disc
Red = Disc inserted

Monitor Angle ▲▼

Press **ANGLE ▲** to increase the monitor view angle.

Press **ANGLE ▼** to decrease the monitor view angle.

Notes:

- Do not attempt to move the monitor up/down by hand - severe damage will occur. Use the front panel buttons or the remote control only.
- The color of the LCD monitor varies between viewing angles. Select the angle with the most optimum view for your location.
- The last position of the monitor will be saved in memory. The monitor will return to its last position automatically the next time it is opened.

INFO/PIC

Press **INFO** button for 1 sec to display DVD disc information.

Press and hold **INFO** for 2 secs to change TFT LCD **BRIGHTNESS**:

Press **ANGLE ▲** to increase, **ANGLE ▼** to decrease or use **VOLUME** rotary to adjust the level up or down, (0 minimum / 20 maximum), 10 is default.

SYSTEM RESET

If you experience abnormal operation or, your unit is inoperable, press the **RESET** button for 3 seconds, located on the front bottom-right corner of the unit. After a system reset, the unit restores all factory default settings.

Notes: Use the tip of a pen to access the button.



Control Locations - Remote

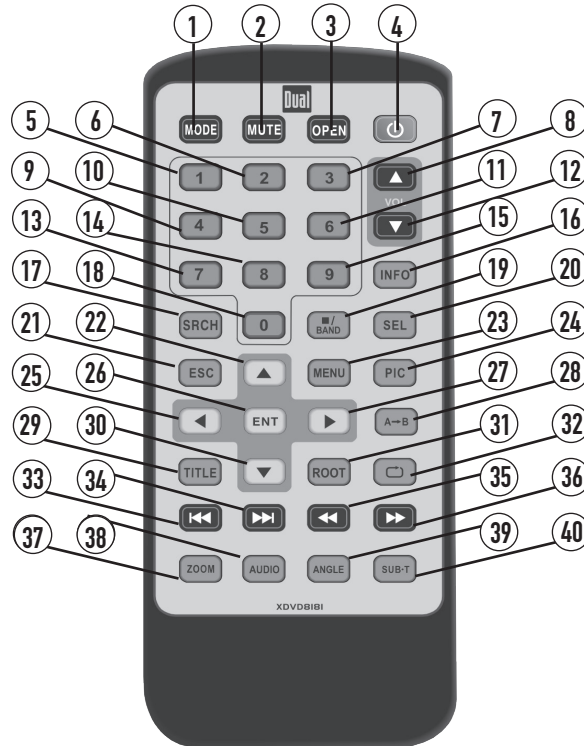

- | | | |
|--------------|---------------|----------------------|
| ① Mode | ⑩ Key #5 | ⑲ Band / Stop |
| ② Mute | ⑪ Key #6 | ⑳ Audio Select |
| ③ Open/Close | ⑫ Volume Down | ㉑ Escape |
| ④ Power | ⑬ Key #7 | ㉒ 4-Way - Up |
| ⑤ Key #1 | ⑭ Key #8 | ㉓ Menu |
| ⑥ Key #2 | ⑮ Key #9 | ㉔ Picture |
| ⑦ Key #3 | | ㉕ 4-Way - Left |
| ⑧ Volume Up | | ㉖ Enter |
| ⑨ Key #4 | | ㉗ 4-Way - Right |
| | | ㉘ Repeat A-B |
| | | ㉙ Title Menu |
| | | ㉚ 4-Way - Down |
| | | ⑳ Info |
| | | ㉛ Search |
| | | ㉜ Key #0 |
| | | ㉝ 4-Way - Up |
| | | ㉞ Menu |
| | | ㉟ Picture |
| | | ㊱ 4-Way - Left |
| | | ㊲ Enter |
| | | ㊳ 4-Way - Right |
| | | ㊴ Repeat A-B |
| | | ㊵ Title Menu |
| | | ㊶ 4-Way - Down |
| | | ㊷ Root |
| | | ㊸ Repeat |
| | | ㊹ Chapter/Track Down |
| | | ㊺ Chapter/Track Up |
| | | ㊻ Fast Rewind |
| | | ㊼ Fast Forward |
| | | ㊽ Zoom |
| | | ㊾ Audio |
| | | ㊿ Angle |
| | | ㊿ Sub-Title |

* The remote control uses one 3 volt Lithium CR2025 battery. For best performance, replace only with CR2025 or equivalent.

Control Functions - Remote

Mode	Press once to incrementally select desired source
Mute	Press once to MUTE audio, press again to return audio
Open/Close	Press once to open monitor, press again to close the monitor
Power	Press once to turn the unit on, press again to turn unit off
Keys 0-9	Direct access chapter/track/preset station for current BAND
Volume Up	Increase VOLUME
Volume Down	Decrease VOLUME
Info	Displays systems information
Search	Search function in the DVD / CD disc
Band / Stop	Press to increment BAND , or STOP while in DVD / MP3 mode.
Audio Select	Enter AUDIO Setup mode
Escape	Exit current menu
4-Way -Up/Down/Left/Right	Navigating system and DVD menus
Menu	Enter the MAIN system menu
Picture	BRIGHTNESS parameter setting for TFT
Enter	Starts/pauses playback or confirm settings
Repeat A-B	Repeat playback from time frame A to time frame B
Title Menu	Enter the title menu on DVD
Root	Enters the main menu of the DVD disc
Repeat	Repeat playback of current DVD chapter
Chapter/Track Down	Selects the previous chapter/track for playback
Chapter/Track Up	Selects the next chapter/track for playback
Fast Rewind	Fast rewind the disc content
Fast Forward	Fast forward the disc content
Zoom	Zooming in/out on an image from DVD disc
Audio	Change the audio language for DVD disc playback
Angle	Plays back DVD disc in different angle for a scene
Sub-Title	Language selection for subtitle



General Operation

Power On/Off

Press Volume knob for 1sec to turn the unit on, the unit will beep 2 times. Press and hold **POWER** for more than 2secs, unit will beep 1 time, then turn off. **NOTE: EJECT** will still function even if **POWER** is off.

Monitor Open/Close

Press **OPEN** to open or close the monitor. The unit will emit 1 confirmation beep when opening, 3 beeps when closing. Be careful not to touch the monitor during the open/close sequence.

Notes:

- The unit will stop automatically during open/close if an obstacle is detected. If this occurs, remove the obstacle and press **OPEN** again to resume the monitor open/close sequence.
- Audio can be heard while the monitor is closed.

Monitor Angle Position

Press **ANGLE ▲** to increase the monitor view angle.
Press **ANGLE ▼** to decrease the monitor view angle.
The monitor angle can be adjusted to 16 different positions.

Notes:

- Do not attempt to move the monitor up/down by hand - severe damage will occur. Use the front panel buttons or the remote control only.
- The color of the LCD monitor varies between viewing angles. Select the angle with the most optimum view for your location.
- The last position of the monitor can be saved in memory. The monitor will return to its last position automatically the next time it is opened.

Notes:

- The vehicle must be in park and the parking brake applied to view video on the in-dash monitor.
- As a safety feature, a blue "**PARKING**" screen will show on the display when the vehicle's parking brake is not engaged. DVD, AV1 audio can be heard while the vehicle is in motion.
- The video display of the in-dash unit will not operate while the vehicle is moving. This is a safety feature to prevent driver distraction. In-dash video functions will only operate when vehicle is in Park and the parking brake is engaged. It is illegal in most states for the driver to view video while the vehicle is in motion. Refer to local laws in your area.

See DVD operation for more details on how to initialize the **PARKING BRAKE**.

General Operation

- Mode** Press **MODE** to select between **TUNER**, **DVD**, **AV1**, **CAMERA**, inputs. Modes of operation are indicated in the **OSD** (On Screen Display) and secondary **LCD**.

- Optional Mode Selection** With the monitor open, press the screen to display the **OSD** menu bar and press **TUNER**, **DVD**, **AV1** or **CAMERA** in the **MAIN** menu page to select the desired source.

- Volume** Adjust **VOLUME** using rotary encoder or the **VOL ▲ ▼** buttons (00-40).

- Mute** Press **MUTE** to silence the audio; **MUTE** will appear in the **OSD**. Press **MUTE** again to cancel.

- Audio Adjustment from front panel** Press in **VOLUME** rotary knob on left front panel, Press in **VOLUME** again to advance to desired parameter to be changed, Turn **VOLUME** rotary or to adjust to desired level, Press in **VOLUME** to advance to next selection, Press and hold the **VOLUME** button on the front panel to exit.

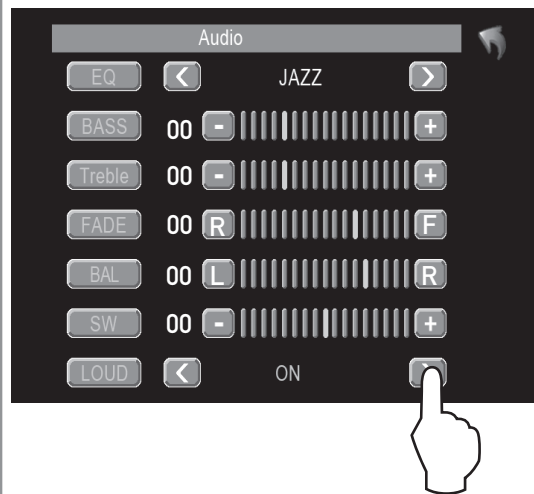

ITEM	RANGE	
EQ	USER	FLAT
	JAZZ	POP
	CLASSIC	ROCK
	NEWS	URBAN
	MOVIE	TECHNO
BASS	-7	+7
TREBLE	-7	+7
FADE	-7	+7
BALANCE	-7	+7
SUB	-7	+7
LOUD	OFF	ON

- Audio Adjustment from Remote** Press the **SEL** button, Press the **▲ ▼** buttons on the remote to select an item to be adjusted, Press **◀ ▶** to adjust the desired setting, Press the **ESC** button on the remote control to exit the audio control menu.

Note: The Bass and Treble levels are only adjustable when EQ is set to "User" mode. The Loud function compensates for deficiencies in sound ranges at low levels. When the Loud function is on, LOUD is displayed on the screen.

General Operation

INFO/PIC

Press **INFO** button for 1 sec to display DVD disc information.

RGB BRIGHTNESS

Press and hold **INFO** for 2 secs to change TFT LCD **BRIGHTNESS**: Press **ANGLE ▲** to increase, **ANGLE ▼** to decrease, or use **VOLUME** rotary to adjust the level up or down. (0 minimum / 20 maximum) 10 is default.

CVBS Screen Controls

While in **Video playback, AUX-IN** or **CAMERA** mode: Press and hold **INFO** for 2 secs to access **PICTURE MENU**, press **INFO** briefly again to step to next selection:

SHARPNESS CONTRAST COLOR BRIGHTNESS TINT

NOTE: Adjustments to **SHARPNESS, CONTRAST, COLOR, BRIGHTNESS & TINT** are only possible while in either **video playback, AUX-IN** or **CAMERA CVBS** mode.



Press ▼ or ▲ to adjust the sharpness (0 minimum / +20 maximum).

Press ▼ or ▲ to adjust the contrast (0 minimum / +20 maximum).

Press ▼ or ▲ to adjust the color (0 minimum / +20 maximum).

Press ▼ or ▲ to adjust the brightness (0 minimum / +20 maximum).

Press ▼ or ▲ to adjust the tint (0 minimum / +20 maximum).

General Operation

BAND	Press BAND to increment from FM1, FM2, FM3, AM1 ⇒ FM1.
AS/PS (Auto Store /Preset Scan)	Press AS/PS for 1 sec to start station PRESET SCAN function, the unit will now scan your program presets for 5 secs for each preset in that band, press again to stop scanning, the front LCD panel will flash while in this mode. Press AS/PS for 2 secs to start AUTO STORE station preset function in current BAND .
DISP	Press the DISP button to display CLOCK information on the secondary LCD screen when the monitor is closed.
OPEN	Press OPEN to open or close the monitor. The unit will emit 1 confirmation beep upon opening, 3 beeps when closing. Be careful not to not touch or obstruct the monitor movement during the open/close sequence, or permanent damage could occur.
EJECT	Press once for DISC ejection.
ROTARY	Press to access MAIN menu, rotate clockwise/counter clockwise to select desired item and press once to ENTER .
MODE	Press once to incrementally select desired source.
TRACK UP	Selects the next chapter/track for playback.
TRACK DOWN	Selects the previous chapter/track for playback
STOP	Stop playback of DVD / CD / MP3
PLAY/PAUSE	Press once for PAUSE , press again for PLAY .
FAST FORWARD	Fast forward the disc content.
FAST REVERSE	Fast reverse the disc content.
MUTE	Press once to MUTE audio, press again to return audio, an icon indicator will flash on the TFT monitor.
POWER ON/OFF	Press VOLUME knob for 1sec to turn the unit on, the unit will beep twice. Press and hold POWER for more than 2secs, unit will beep three times, then turn off. NOTE: EJECT will still function even if POWER is off.
VOLUME	Rotate VOLUME rotary knob ↻ or ↺ for desired VOLUME level, press once to access the AUDIO SETUP MENU .
PROGRAMMABLE TURN-ON VOLUME	Turn VOLUME rotary to desired listening level, press and hold VOLUME rotary knob for 3 seconds to program currently selected volume level.



XDVD8181 OPERATION

General Operation



Secondary LCD Information

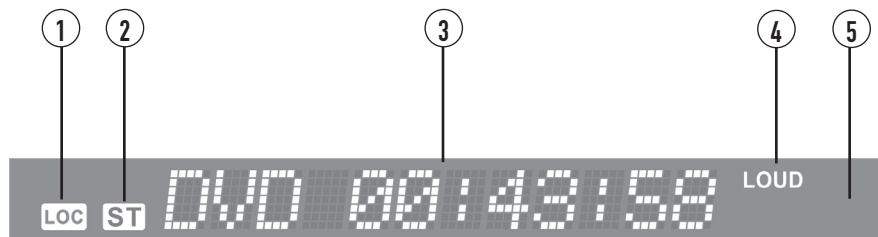

NOTE: Sub-LCD only functions when TFT monitor is closed.

- 1) **LOC** LOCAL indicator, icon will be off when **DISTANT (DX)** is selected
- 2) **ST** STEREO radio station indicator
- 3) **TIME** Displays **TRACK** time, **TUNING** frequency, **MP3 ID3** info, & **CLOCK**, etc
- 4) **LOUD** LOUDNESS selection indicator

General Operation

Main Menu Access

There are three methods to access the MAIN menu

- Press the ENTER button on the right ROTARY knob
- Press the MENU button on the IR Remote control
- Touch the A area (upper left hand side) on the touch screen

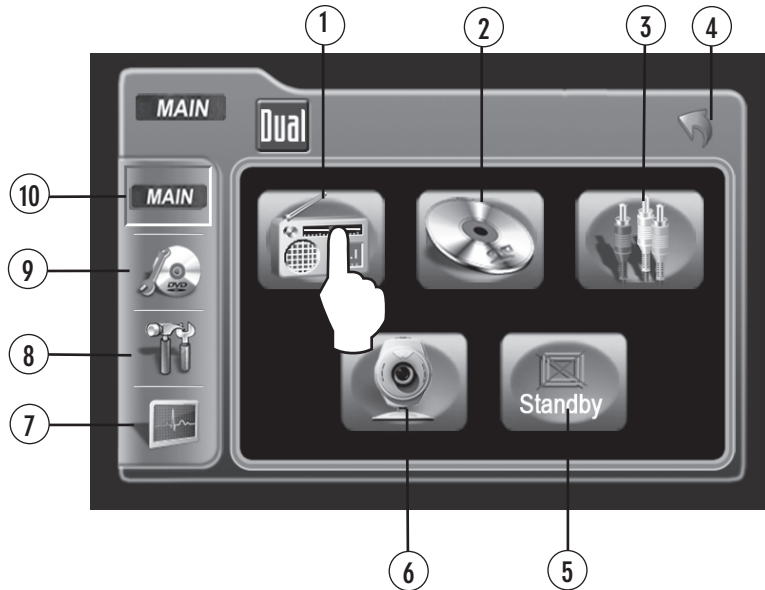

Touch Access Buttons

- 1) Touch to access **AM/FM TUNER** mode
- 2) Touch to access **CD/DVD** mode, **CD/DVD** must be inserted
- 3) Touch to access **AUXILIARY A/V INPUT** mode
- 4) Touch to **RETURN** to previous screen
- 5) Touch to access **CAMERA** mode, if optional camera isn't connected then "No Video Signal" will be displayed
- 6) Touch to **STANDBY** screen, touch screen again or any button to resume display.
- 7) **NOTE: VOLUME** level can be controlled without interrupting **STANDBY**
- 8) Touch to access **SCREEN SETUP** utility menu
- 9) Touch to access **GENERAL SETUP** utility menu
- 9) Touch to access **CD/DVD SETUP** menu, **CD/DVD** must be inserted to function
- 10) Touch to access **MAIN** Source menu

Rapid Dial

RAPID DIAL can also control touch screen functions

- Select desired function rotating clockwise or counter-clockwise
- Function will be outlined in yellow
- Press inward to **ENTER**

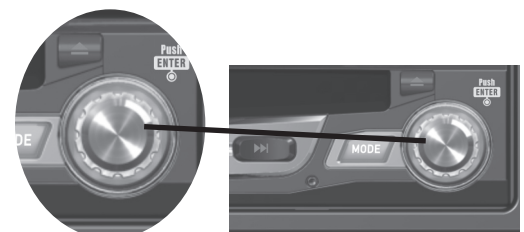

System GENERAL Setup Menu

General Setup Menu

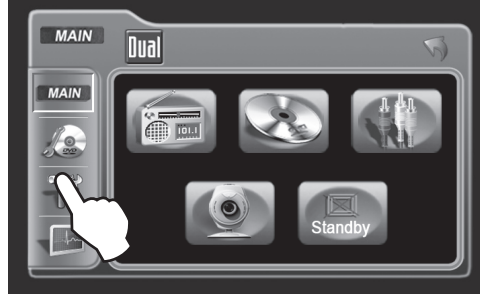

- Press the GENERAL button to access the setup mode
- Select desired parameter you wish to change
- Page will return back to previous screen after 10 secs of inactivity or by pressing the RETURN button

NOTE:
Default anti-theft password
is 0000

This is matrix of the GENERAL Setup Menu

Settings	Default	Options	Function
Radio	USA	USA	Set to appropriate setting for your Country
		S-AMER1	
		S-AMER2	
		Europe	
Clock adjust	AM	00:00	See adjusting the clock for more details
Clock Mode	12Hr	12Hr	PM 6:00
		24Hr	18:00
Camera Image	Normal	Normal	Normal Image
		Reverse	Mirror camera input image 180 degrees
Video Format	Auto	AUTO	System will auto detect NTSC or PAL
		NTSC	For NTSC compatibility
		PAL	For PAL compatibility
TFT Auto Open	Off	On	TFT panel will automatically open when IGN is turned on
		Off	TFT will remain closed until the OPEN button is pressed
		Manual	Will only close when OPEN
Antitheft code	0000	----	Must enter password to turn antitheft on or off
Antitheft Active	Off	On	System will require a password if main battery power is removed for more than 5 minutes
		Off	No Password will be required if power is removed
Load Factory Defaults	Yes	Are you sure? Yes / Cancel	Load all factory parameters to their original settings. NOTE: this will not change ANTI-THEFT password

NOTE: Not all GENERAL setup features are described in detail

System GENERAL Setup- Adjusting RADIO Frequency

Adjusting RADIO Frequency

Step 1

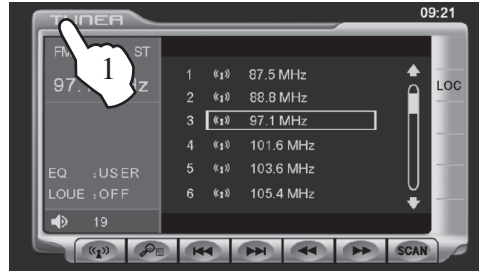

1) Touch top left corner of screen

Step 2

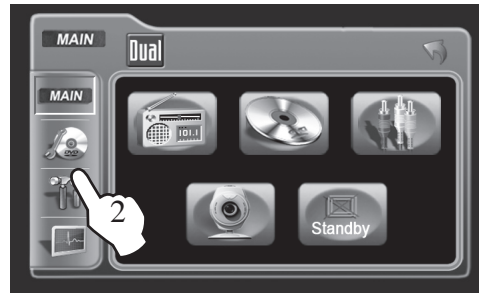

2) Touch GENERAL setup button

Step 3

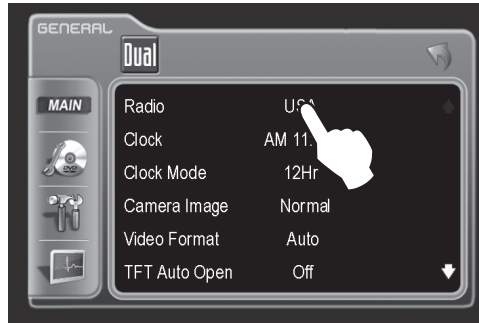

3) Touch USA

Step 4

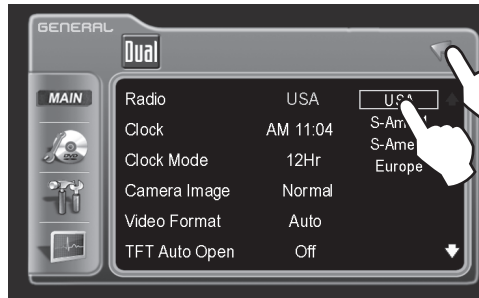

4) Touch the setting for your Country

Step 5

Touch RETURN to exit

System GENERAL Setup- Adjusting the Clock

12Hr Clock Mode

Step 1

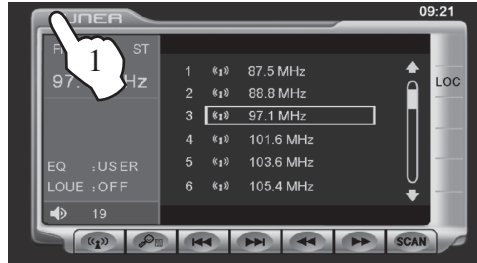

1) Touch top left corner of screen

Step 2

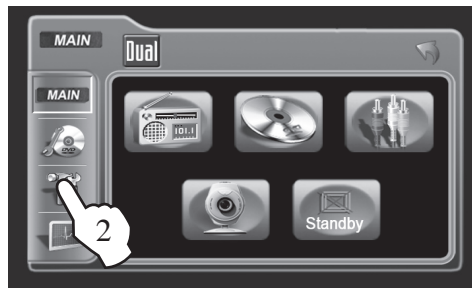

2) Touch GENERAL setup button

Step 3

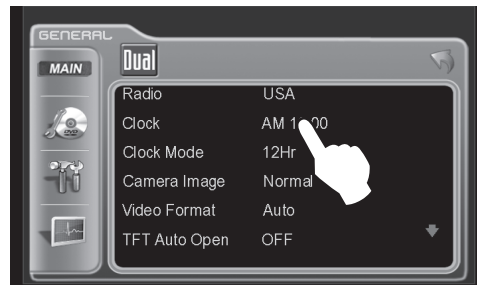

3) Touch 00:00 area in the CLOCK row

Step 4, 5, 6, 7 & 8

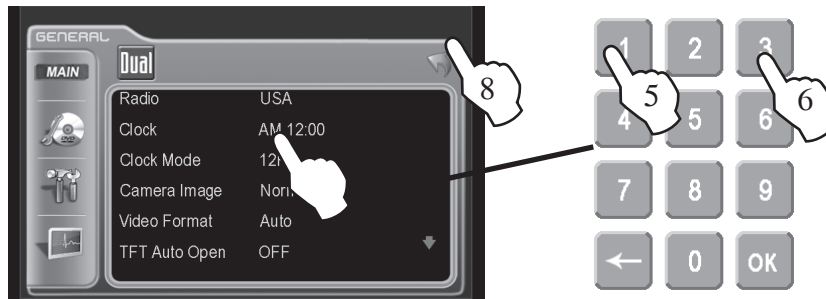

- 4) Keypad should now appear
- 5) Enter the time in HOURS, touch Ok
- 6) Enter MINUTES, touch Ok
- 7) Touch AM or PM to set
- 8) Touch RETURN to exit

24Hr Clock Mode

If you desire 24Hr format, select 24Hr from CLOCK MODE, then follow steps 1-8

System GENERAL Setup- Setting the Anti-theft code

By default Anti-theft password is 0000 and is turned OFF, to turn this feature on, follow the steps below.
CAUTION!!
 This will lock your unit from operating if battery POWER is disconnected for more than 5 minutes

Step 1 & 2

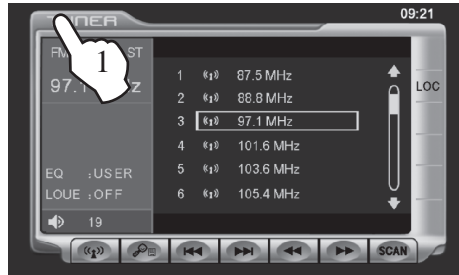

1) Touch top left corner of screen

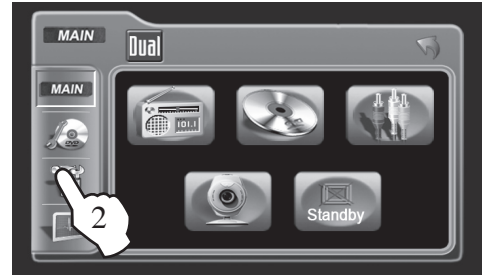

2) Touch GENERAL Setup button

Step 3 & 4

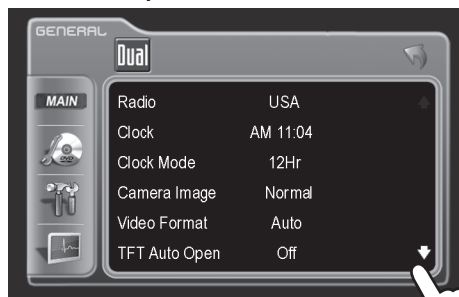

3) Touch down arrow button

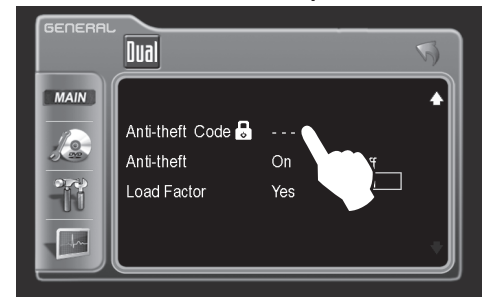

4) Touch ----

Step 5 & 6

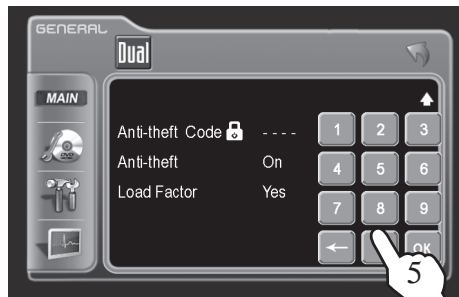

5) Enter 0000

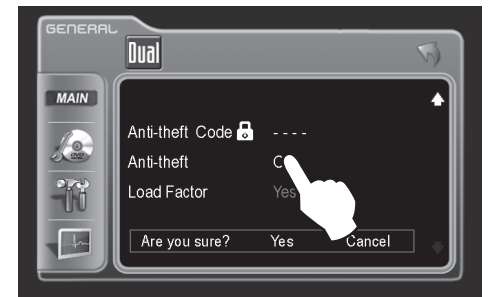

6) Touch OFF

Step 7 & 8

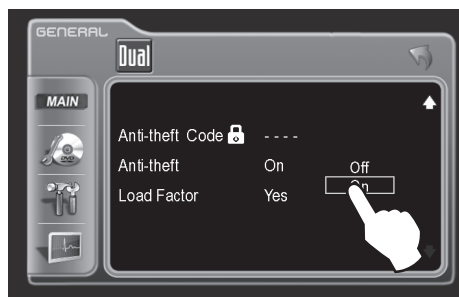

7) Touch ON

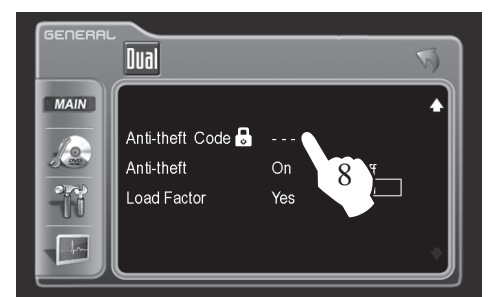

8) Touch ---- again

NOTE: it is recommended that you choose your own 4-digit password carefully, write it down somewhere and keep in a safe location. In the event you should ever loose or forget your password, call our tech hot line for support on how to unlock your system

Step 9 & 10

Record your password here

□ □ □ □

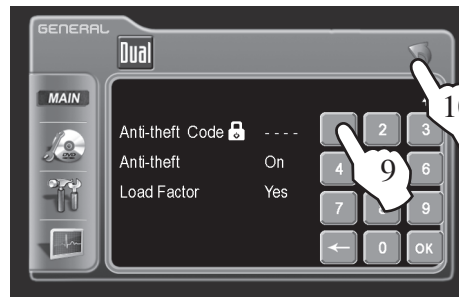

9) Enter your new 4-digit password

10) Touch RETURN to exit

System SCREEN Setup Menu

Screen Setup Menu

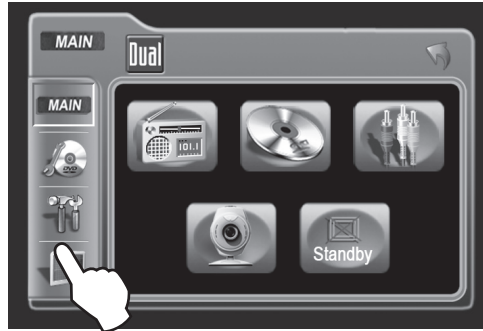

- Press the SCREEN Setup button to access the SCREEN SETUP mode
- Select desired parameter you wish to change
- Page will return back to previous screen after 10 secs of inactivity or by pressing the RETURN button

Adjusting a Feature

Settings	Default	Options	Function
Brightness	10	0 to +20	Press the < / > buttons on the remote or rotate the ENTER button clockwise / count-clockwise to adjust the BRIGHTNESS to the desired setting
Screen Tilt	4	1 - 6	Select 1 to 6 to adjust the default tilt angle of the screen
Screen Saver	On	On	Select On to activate the screen saver, Off to deactivate
		Off	
Touch Screen Calibration	No	No	Touch "Yes" to enter the Touch Screen calibration mode
		Yes	
Version			Software version of unit

System Standby

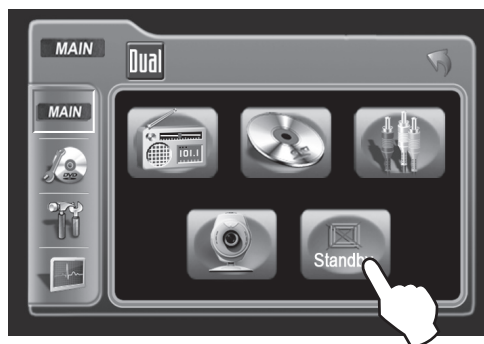

To conserve the LCD backlight lifespan or to stop annoying glare while night driving, press STANDBY, the TFT screen only will black out, however all other operations are still possible, press any button except **VOLUME** or touch screen again to return normal viewing

System SCREEN Setup Menu- Setting TFT Brightness

This will set the default setting for the TFT display brightness, this setting can also be set by pressing the INFO button on the front TFT panel

Step 1

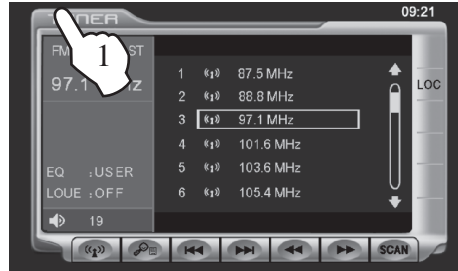

1) Touch top left corner of screen

Step 2

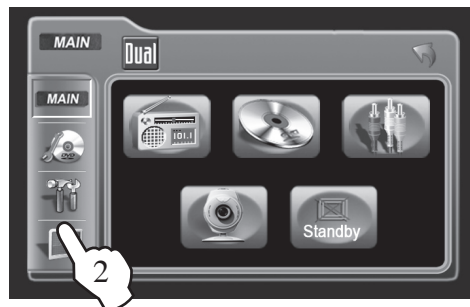

2) Touch SCREEN setup button

Step 3

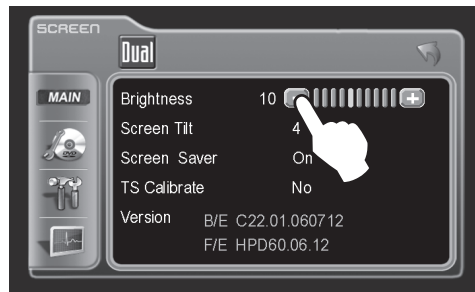

3) Touch [-] to DIM TFT

Step 4

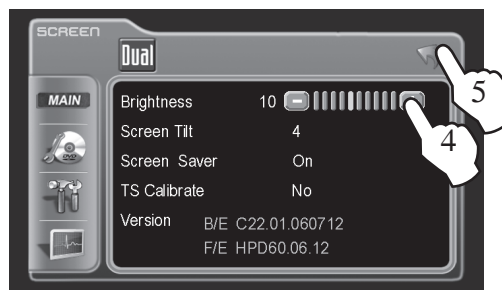

4) Touch [+] to BRIGHTEN TFT

0 to + 20 is possible
Default = 10

Step 5

5) Touch RETURN to exit

System SCREEN Setup- Setting TFT Angle

Set for best viewing angle in your vehicle

Step 1

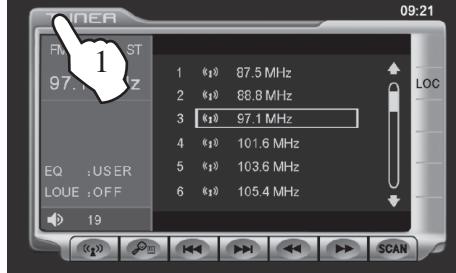

1) Touch top left corner of screen

Step 2

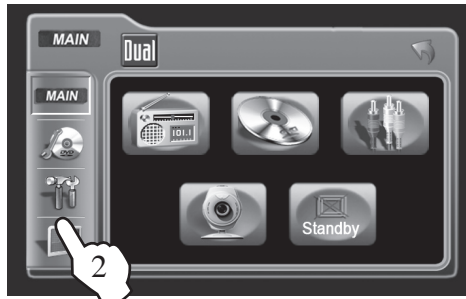

2) Touch SCREEN setup button

Step 3

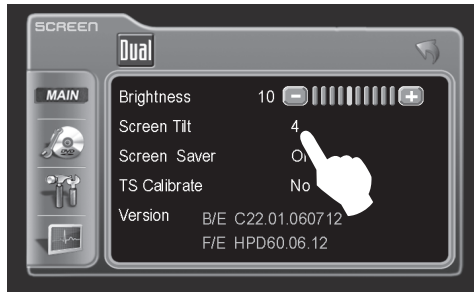

3) Touch a number displayed in SCREEN TILT row

Step 4



4) Touch desired angle for best viewing angle

1 -6 is possible
Default = 4

Step 5

5) Touch RETURN to exit

System SCREEN Setup - Touch Screen Calibration

On occasion the touch screen will have to be calibrated, follow these few steps as described

Step 1

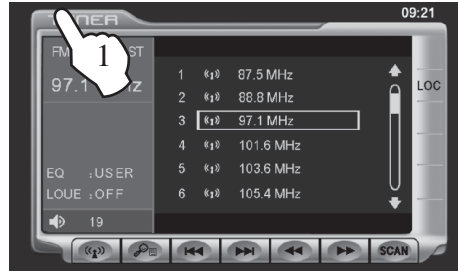

1) Touch top left corner of screen

Step 2

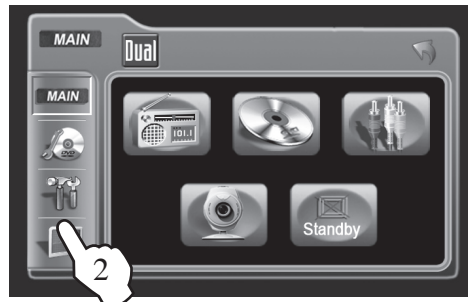

2) Touch SCREEN setup button

Step 3 & 4

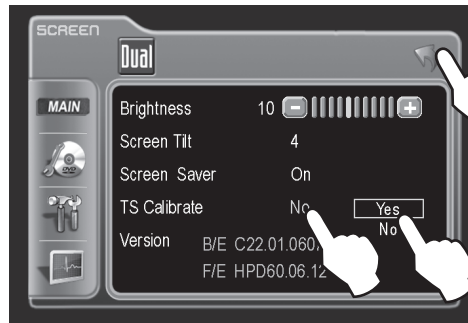

3) Touch NO in TS Calibration row
4) Then press YES

Step 5 & 6

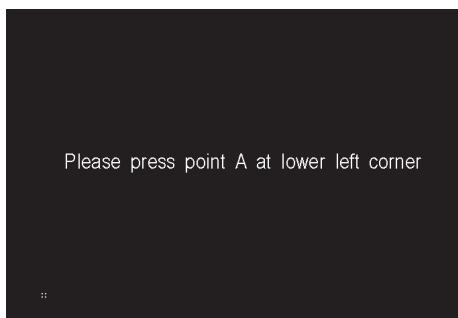

5) Touch and hold the pointers as indicated on the screen for 2 seconds each.
6) Screen will automatically return to MAIN MENU, touch EXIT to return.

Note: For proper calibration you must touch each pointer for 2 seconds. If pointers are not touched properly, the calibration sequence will start over until the calibration is done correctly.

AM/FM Tuner Operation

AM/FM Tuner TFT Display

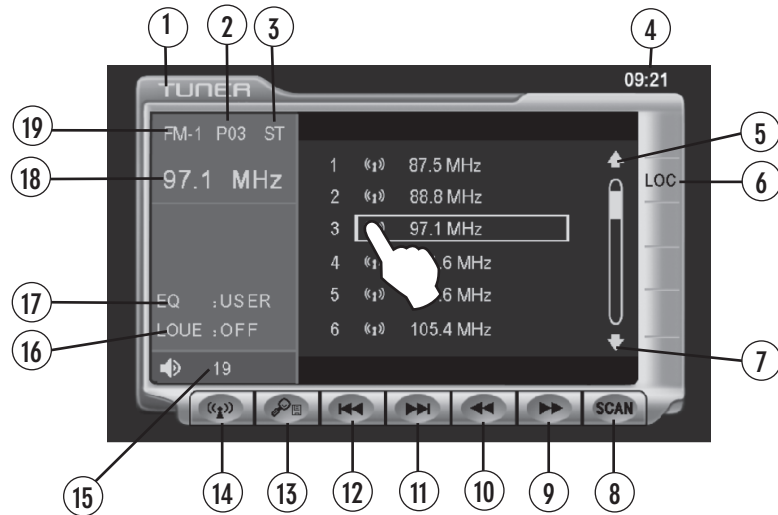

- 1) Current source **MODE** information, touch "A" area to return to **MAIN** source selection menu
- 2) Current **PRESET** station indicator
- 3) **STEREO** broadcast indicator
- 4) **Clock**
- 5) **PRESET** page up
- 6) **LOCAL / DISTANCE** selection
- 7) **PRESET** page down
- 8) Auto station **SCAN** button
- 9) **MANUAL TUNE** up
- 10) **MANUAL TUNE** down
- 11) **SEEK TUNE** up
- 12) **SEEK TUNE** down
- 13) **AS/PS** (AUTO STORE / PRESET SCAN)
- 14) **BAND** selection, FM1, FM2, FM3, AM -> FM1
- 15) **VOLUME** indicator
- 16) **LOUD** indicator
- 17) Equalizer indicator, touch to access **AUDIO** Setup menu
- 18) Current radio frequency indicator
- 19) Current radio **BAND** indicator

AM/ FM Tuner Operation

- Auto Seek Tuning** Press the button to auto **SEEK** up the next strongest station.

Press the button to auto **SEEK** down the next strongest station.
- Manual Tuning** Press the button to manually tune up one step at a time.

Press the button to manually tune down one step at a time.
- Auto Store (AS)** Press and hold **AS/PS** for more than 2 seconds to automatically store the twelve strongest stations in the current band. Automatic Local tuning is activated during the initial band scan, repeat for other bands.

NOTE: All presets within the current band will be overwritten.
- Program Scan (PS)** Press **AS/PS** for less than 2 seconds to scan presets 1-12 on the current band, pausing for 5 seconds at each. Press **AS/PS** again to cancel.
- SCAN** Press **SCAN** to preview strong stations on the current band, pausing for 5 seconds at each station. Press **SCAN** again to cancel.
- LOC/DX Radio Station** Touch **LOC** button on the TFT to activate **LOC / DX**
When the **LOCAL** function is on, **LOC** will appear, only radio stations with a strong signal are received, **DX** is for radio stations that are far away and/or have weak signals.
- Storing Radio Stations PRESET** Up to 36 FM stations and 12 AM stations can be stored. To store a station, select the desired band and station. Press and hold the desired preset button (1-12) for more than 2 seconds. When stored, the **PRESET** number will appear in the display. The station can be recalled anytime by pressing the corresponding preset button on the TFT.
- Recalling a Radio Station PRESET** Touch an corresponding **PRESET** number for less than 2 secs to recall.
- PRESET Page Up/Down** Only 6 PRESETS can be display at one time, use PRESET page up/down to access next stored PRESETS accordingly.

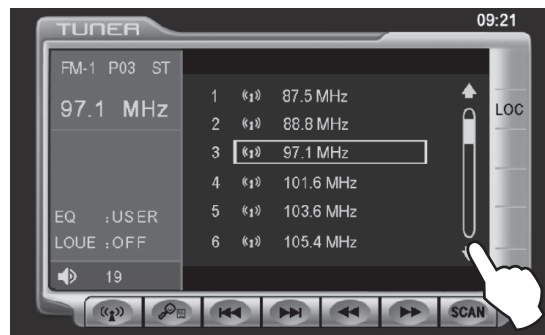



XDVD8181 OPERATION

DVD Operation

DVD Region Management

Some DVD discs can be played only in certain playback modes according to the intentions of the software. As the XDVD8181 plays discs according to their intentions, some functions may not work as intended. Please be sure to read the instructions provided with each disc. This player has been designed to play back DVD software that has been encoded for specific region areas. It cannot play back DVD software encoded for other region areas than the region areas for which it has been designed.

The XDVD8181 will play discs labeled "Region 1" or "All".

DVD region codes:

- 1 - USA, Canada
- 2 - Japan, Europe, South Africa, Middle East
- 3 - Rep. of Korea, Taiwan, Hong Kong, Parts of Southeast Asia
- 4 - Australia, New Zealand, Mexico, South America
- 5 - Eastern Europe, Russia, India, Africa
- 6 - China



DVD Disc Symbols

Symbol	12cm Disc Properties	Max Play Time
	Single side single layer (DVD-5) Single side double layer (DVD-9) Double side single layer (DVD-10) Double side double layer (DVD-18)	(MPEG 2 Method) 133 minutes 242 minutes 266 minutes 484 minutes
	Single side single layer (VCD)	(MPEG 1 Method) 74 minutes
	Single side single layer	74 minutes

Symbol	Meaning
	Number of voice languages recorded. The number inside the icon indicates the number languages on the disc (maximum of 8).
	Number of subtitle languages available on the disc (maximum of 32).
	Number of angles provided (maximum of 9).
	Aspect ratios available. "LB" stands for Letter Box and "PS" stands for Pan/Scan. In the example on the left, the 16:9 video can be converted to Letter Box video.
	Indicates the region code where the disc can be played. <ul style="list-style-type: none"> · Region 1: USA, Canada, East Pacific Ocean Islands · Region 2: Japan, Western Europe, Northern Europe, Egypt, South Africa, Middle East · Region 3: Taiwan, Hong Kong, South Korea, Thailand, Indonesia, South-East Asia · Region 4: Australia, New Zealand, Middle and South America, South Pacific Ocean Islands/ Oceania · Region 5: Russia, Mongolia, India, Middle Asia, Eastern Europe, North Korea, North Africa, North-West Asia

Notes:

Some DVD discs can be played only in certain playback modes according to the intentions of the software. As the XDVD8181 plays discs according to their intentions, some functions may not work as intended. Please be sure to read the instructions provided with each disc.

DVD Operation - Parking Brake Initialization



CAUTION !!!
 IT'S UNLAWFUL TO OPERATE
 A VEHICLE WHILE VIDEO IS
 DISPLAY IN THE DRIVERS
 VIEWING AREA

ENGAGE EMERGENCY BRAKE
 TO ENJOY VIDEO

SAFETY WARNING



- The video display of the in-dash unit will not operate while the vehicle is moving. This is a safety feature to prevent driver distraction. In-dash video functions will only operate when vehicle is in Park and the **PARKING BRAKE** is engaged. It is illegal in most states for the driver to view video while the vehicle is in motion. Refer to local laws in your area.
- Audio can be heard while the monitor is closed.
- The vehicle must be in park and the parking brake applied to view video on the in-dash monitor.
- As a safety feature, “**ENGAGE PARKING BRAKE**” blue screen will show on the display when the vehicle's parking brake is not engaged. Video display on the front monitor isn't allowed until the **PARKING BRAKE** is active. After connecting the yellow/blue **PARKING BRAKE** wire to brake switch circuit as described below, note however, DVD and AV1 audio can be heard while the vehicle is in motion without engaging the parking brake.

Front TFT Video Initialization

Follow this two initialization procedure carefully to allow video playback on XDVD8181 front panel TFT:

There are usually two situations that start the **PARKING BRAKE** Sequence.

**Parking Brake Initialization
 Situation 1**

First situation is while driving:

- 1) Stop vehicle, put in Park, make sure **PARKING BRAKE** is off / released
- 2) Depress **PARKING BRAKE** for 1 sec
- 3) Release **PARKING BRAKE** for 1 sec
- 4) Depress **PARKING BRAKE** permanently

NOTE: Once above procedure 1-4 is completed, approx 3sec—video will display.

**Parking Brake Initialization
 Situation 2**

Second situation is while already parked and the **PARKING BRAKE is already depressed:**

- 1) Keep vehicle in Park, **PARKING BRAKE** should be off
- 2) Release **PARKING BRAKE** for 1 sec
- 3) Depress **PARKING BRAKE** for 1 sec
- 4) Release **PARKING BRAKE** for 1 sec
- 5) Depress **PARKING BRAKE** permanently

NOTE: Once 2nd procedure is completed, approx 5 sec—video will display.

NOTE: This procedure will have to repeated if the **IGN** is turned off.

Note: The transition time must be less than 2 sec between depressed and release

DVD Operation - Inserting a Disc

DVD Loading Slot



Eject button

Insert CD/DVD with label facing upwards

Inserting a DISC

When inserting a DVD disc, it will play automatically. Other sub-menus may have to be pressed to access the DVD movie / music content, read the directions of your specific DVD disc for hidden features.

NOTE: If PARENTAL Lock is activated and the disc inserted is not authorized, a 4-digit code must be entered and/or the disc be authorized.(see "RATING MENU")

NOTE: Only one disc can be inserted at a time.

Ejecting the DISC

Press the EJECT button

Resetting the Loading Mechanism

If the disc loads abnormally or an system error occurs, press and hold the eject button for 3secs to reset the loading mechanism. The disc will eject and normal operation should resume.

DVD Operation - Touch Screen

Hidden Touch Screen area while in TUNER mode

There are several hidden TOUCH SCREEN areas outlined below.

"A" area can be used in any mode to access MAIN menu



Hidden Touch Screen areas while in DVD mode

"A-F" areas can be used in DVD mode to access:

- A - MAIN menu access
- B - Displays DVD track information
- C - Selects PREVIOUS chapter
- D - Select NEXT chapter
- E - Displays the full DVD transport controls
- F - GOTO search menu



DVD Operation - Touch Screen Controls

Using the hidden Touch Screen Controls

- A - MAIN menu access
- B - Displays DVD track information
- C - Selects PREVIOUS chapter
- D - Select NEXT chapter
- E - Displays the full DVD transport controls
- F - GOTO search menu

NOTE: A DVD disc must be inserted to access these functions and features.

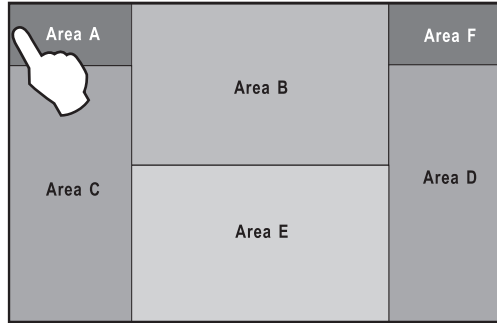

AREA A
Access MAIN Menu

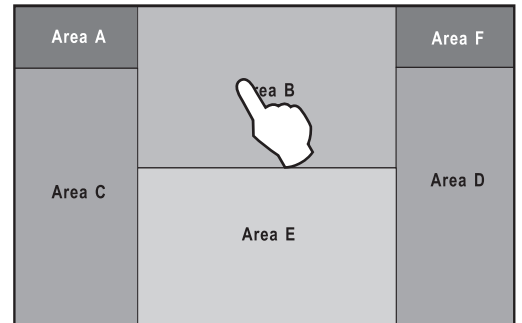

AREA B
Displays Track Information

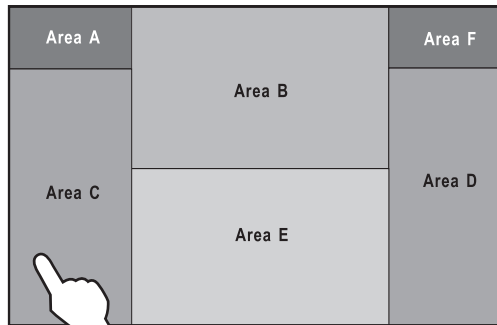

AREA C
Selects PREVIOUS Track

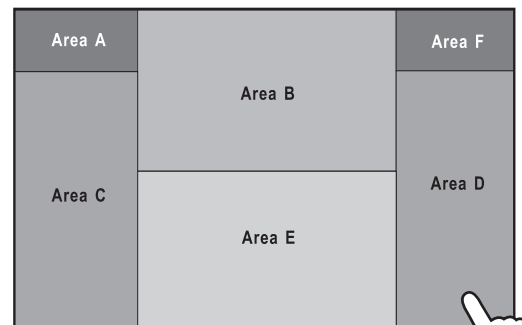

AREA D
Selects NEXT Track

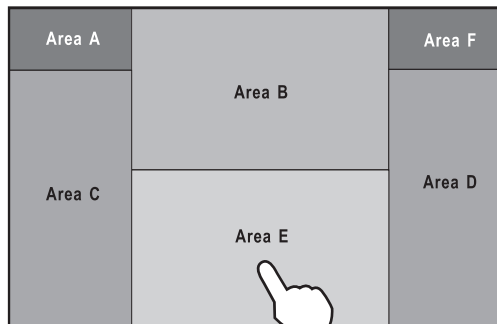

AREA E
Full DVD Transport Controls

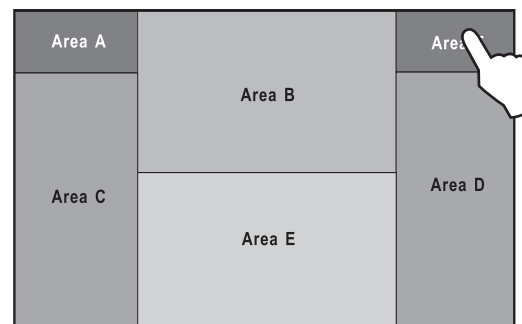

AREA F
DVD Search

DVD Operation - Touch Screen Controls

Using the hidden Touch Screen Controls

Touch AREA E



- 1) Touch the PLAY button or on the front panel to resume disk playback.
Touch the PAUSE button again to suspend the disc playback.
- 2) Touch the STOP button to STOP playback, touch or OK on the remote to resume playback.
- 3) Touch the REVERSE button to FAST REVERSE on DVD, 2x, 4x, 8x to 20x.
- 4) Touch the FF button to FAST FORWARD on DVD, 2x, 4x, 8x to 20x.
- 5) Touch the Repeat to scroll through the following:
DVD: Repeat Title, Repeat Chapter, Repeat OFF
MP3: Repeat Single, Repeat Folder, Repeat OFF
- 6) Touch the A-B to scroll through the following:
 - A) Use the A-B function to define a specific area of disc to repeat. Press the Repeat A-B button to set a start point of the (A) selection.
 - B) Press the A-B button again once you reach the desired end point (B) of the repeated section, the selected portion of the DVD will now repeat continuously.
 - C) Press A-B button once again to cancel the A-B selection and stop repeat playback
- 7) Touch the to change Audio language playback
- 8) Touch the to return to MAIN MENU of DVD
- 9) Touch the to change Sub-title of DVD

Notes:

Some DVD discs can be played only in certain playback modes according to the intentions of the software. As the XDVD8181 plays discs according to their intentions, some functions may not work as intended. Please be sure to read the instructions provided with each disc.

DVD Operation - Searching a DVD

Searching a DVD

Searching by Time, Title, or Chapter

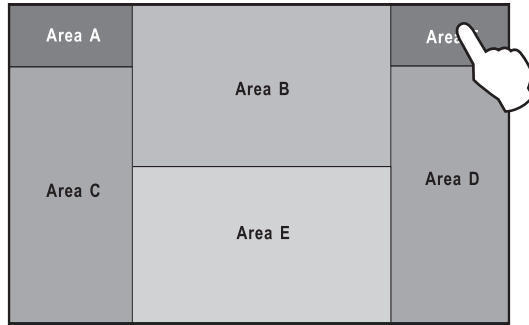

Touch the search  button in AREA F.

- 1) Touch the  in the TIME area.
- 2) A touch keypad will now appear, enter your desired TIME to search.
- 3) Enter OK.

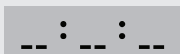
Search
Time 
Title/Chapter --- / ---





DVD Operation

Direct Chapter / Track Selection

During DVD and CD playback, you can use the numeric keypad on the IR remote to access tracks directly

Viewing an Alternate picture Angle (DVD only)

Some DVD's contain scenes that have been shot simultaneously from different angles. For discs recorded with multiple angle, press the ANGLE button on the remote control to toggle between available angles on the screen.

Multi-Language Disc

If you are watching a disc recorded in multiple languages, press the AUDIO button on the IR remote to choose your desired language. You can also touch AREA E and use the  button to change languages.

Changing Subtitle Language

If you are watching a disc recorded in multiple languages with subtitles, press the SUB-T button on the IR remote to choose your desired subtitle. You can also touch AREA E and use the  button to change languages.

DVD Playback Information

During playback, press the INFO button on the IR remote or touch AREA B to display the playback information on screen.

The following information will be displayed:



Playback Information

- 1) Indicates current source playing.
- 2) Indicates that the fourth of sixteen title on the DVD is currently playing.
- 3) Indicates that the first of twenty chapters on the DVD is currently playing.
- 4) Indicates the playback time if the current title.
- 5) Indicates the USER defined EQ levels
- 6) Indicates the LOUND setting is on.
- 7) Indicates the current system time.



DVD Setup Menu - Language

LANGUAGE Setup Menu

NOTE: A DVD disc must be inserted to access these functions and features.

With the monitor open in DVD mode, press the AREA A (top left screen) to display the MAIN menu bar. Press **DVD Setup** to access the DVD setup menu.

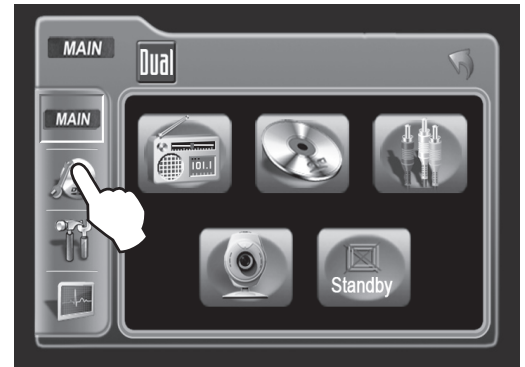

Press **LANGUAGE** icon to select **LANGUAGE** setup page.

Disc Subtitle

Press to select desired disc subtitle language.

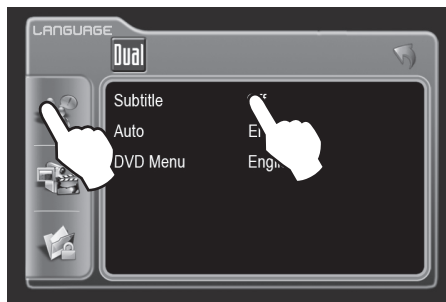

- ENGLISH
- FRENCH
- SPANISH
- AUTO
- OFF = DEFAULT

Subtitle Language

Press to select desired disc audio language.

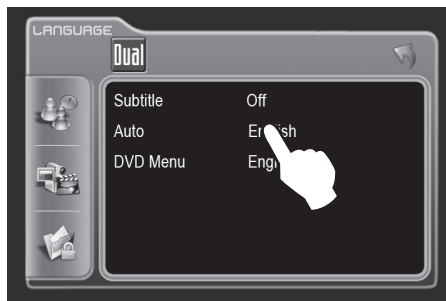

- ENGLISH = DEFAULT
- FRENCH
- SPANISH

DVD Menu

Press to select desired disc menu language.

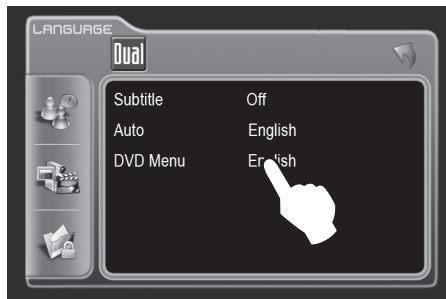

- ENGLISH = DEFAULT
- FRENCH
- SPANISH

DVD Setup Menu - Video

Video Setup Menu

NOTE: A DVD disc must be inserted to access these functions and features.

With the monitor open in DVD mode, press the AREA A (top left screen) to display the MAIN menu bar. Press **DVD Setup** to access the DVD setup menu.

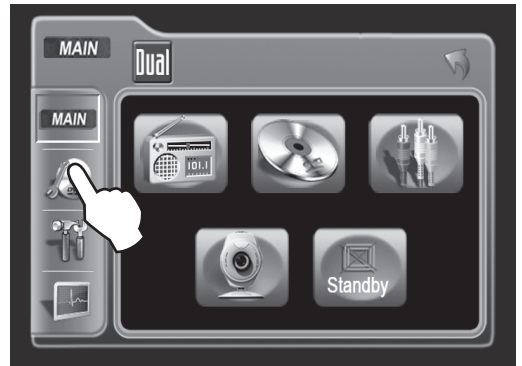

Press **VIDEO** icon to select from the following menus:

TV Shape

Press to select desired TV Shape.

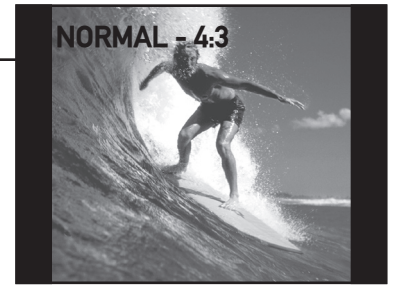
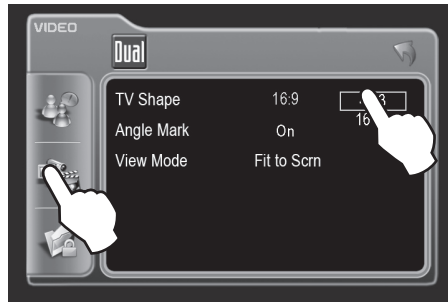

Angle Mark

Press to select desired Angle Mark.

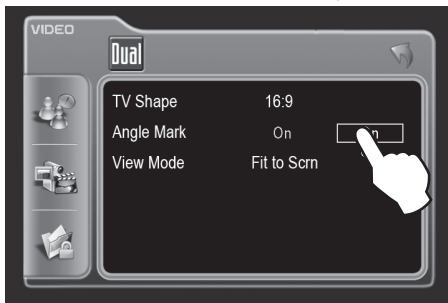

ON
OFF



Video Mode

Press to select desired Video mode.

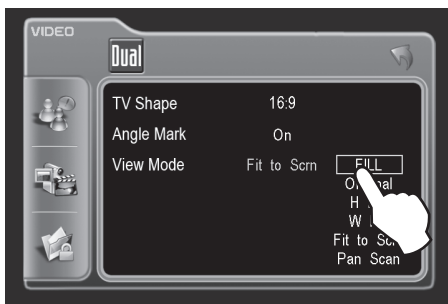

FILL
ORIGINAL
H FIT
W FIT
FIT TO SCRNM
PAN SCAN

DVD Setup Menu- Ratings

Ratings Setup Menu

NOTE: A DVD disc must be inserted to access these functions and features.

With the monitor open in DVD mode, press the AREA A (top left screen) to display the MAIN menu bar. Press **DVD Setup** to access the DVD setup menu.

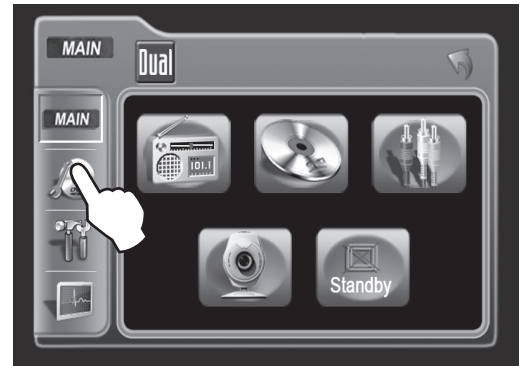

Press **RATING** icon to select from the following menus:

Enable Parental Lock Password

Press ---- to enter a your desired password.

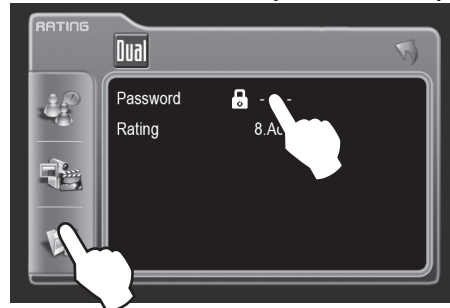

Setting Parental Lock Password

1. Enter a 4-digit code
2. Write the code down
3. Save in a safe place

Rating Setting

Press to select desired Rating Setting.

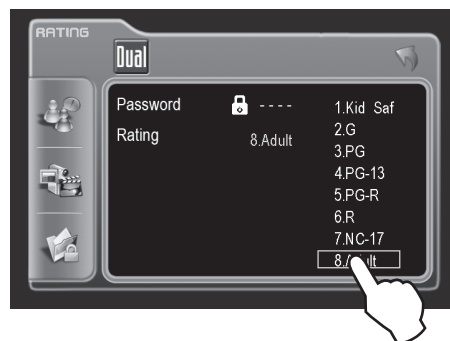

1. Kid Safe
2. G
3. PG
4. PG-13
5. PG-R
6. R
7. NC-17
8. Adult

Parental Password Override

In the event you forget or loose your **PARENTAL LOCK** password, enter 9991

SVCD Operation - Touch Screen Controls

Using the hidden Touch Screen Controls

Touch AREA E

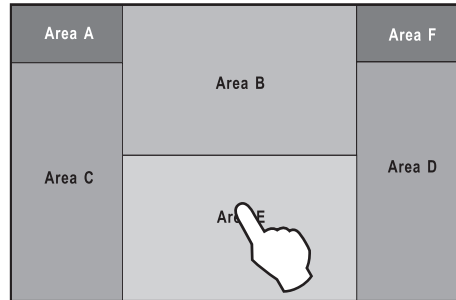

SVCD Transport Control OSD



- 1) Touch the **PLAY** button or on the front panel to resume disk playback.
Touch the **PAUSE** button again to suspend the disc playback.
- 2) Touch the **STOP** button to **STOP** playback, touch or OK on the remote to resume playback.
- 3) Touch the **REVERSE** button to FAST REVERSE on SVCD, 2x, 4x, to 8x
- 4) Touch the **FF** button to FAST FORWARD on SVCD, 2x, 4x, to 8x.
- 5) Touch the **REPEAT** button to scroll through the following:
Repeat Disc, Repeat OFF
- 6) Touch the to control the following:
 - A) Use the A-B function to define a specific area of disc to repeat. Press the Repeat A-B button to set a start point of the (A) selection.
 - B) Press the A-B button again once you reach the desired end point (B) of the repeated section, the selected portion of the DVD will now repeat continuously.
 - C) Press A-B button once again to cancel the A-B selection and stop repeat playback
- 7) Touch the to change AUDIO settings of SVCD.
LEFT
RIGHT
STEREO

Notes:

Some recorded SVCDs may be incompatible with this unit, depending on media type and recording method.

CD Operation

CD USER Interface

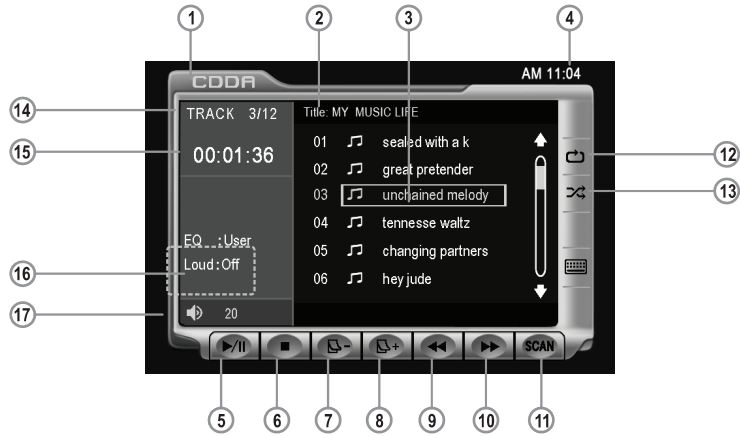

- 1) Current source indicator, touch AREA A to access MAIN source menu
- 2) Disc title.
- 3) Track title.
- 4) Current TIME.
- 5) Touch to PLAY / PAUSE disc playback.
- 6) Touch to STOP disc playback.
- 7) Touch to PAGE down.
- 8) Touch to PAGE up.
- 9) Touch to FAST REVERSE current track.
- 10) Touch to FAST FORWARD current track.
- 11) Touch to SCAN CD tracks for 9sec each track, touch again to deactivate.
- 12) Touch to activate / deactivate REPEAT: Single mode.
- 13) Touch to activate / deactivate RANDOM mode.
- 14) Current track and total number of tracks on the disc.
- 15) Elapsed playback time.
- 16) Playback information.
- 17) Volume indicator.

CD Operation

Playing CDDA files

After inserting a CD disc, files will play in numerical order in the directory.



Selecting by Single Track

Touch to playback track



Selecting by Direct Track Access

Touch to for DIRECT TRACK access



Previous / Next Page

Touch to view UP / DOWN pages of available TRACKS

MP3/WMA Operation

MP3/WMA USER Interface

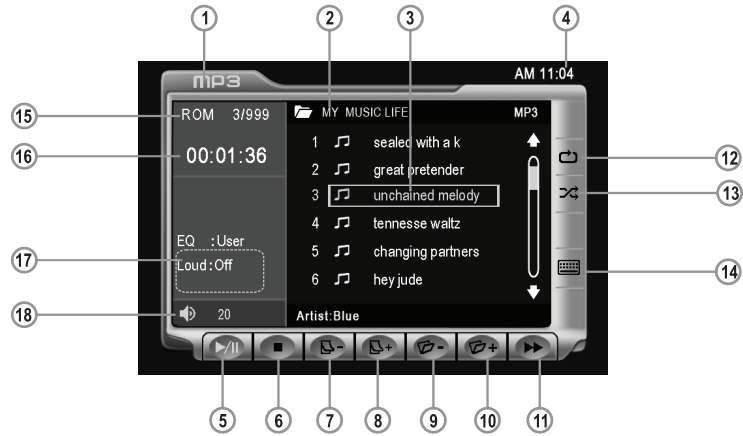

- 1) Current source indicator, touch AREA A to access MAIN source menu
- 2) Disc title.
- 3) Track title.
- 4) Current TIME.
- 5) Touch to PLAY / PAUSE disc playback.
- 6) Touch to STOP disc playback.
- 7) Touch to PAGE down.
- 8) Touch to PAGE up.
- 9) Touch to PREVIOUS FOLDER.
- 10) Touch to NEXT FOLDER.
- 11) Touch to FAST FORWARD MP3 tracks, touch PLAY to deactivate.
- 12) Touch to activate / deactivate REPEAT: Single mode.
- 13) Touch to activate / deactivate RANDOM mode.
- 14) Touch to access the DIRECT TRACK access keypad.
- 15) Current track and total number of tracks on the disc.
- 16) Elapsed playback time.
- 17) Playback information.
- 18) Volume indicator.

MP3/WMA Operation

Playing MP3/WMA files

After inserting a CD disc, files will play in numerical order in the directory.



Selecting by Single Track

Touch to playback track



Selecting by Direct Track Access

Touch to for DIRECT TRACK access



Previous / Next Page

Touch to view UP / DOWN pages of available TRACKS



Media Compatibility

Additional MP3/WMA Information

An internal buffer provides ESP (Electronic Skip Protection) to virtually eliminate skipping.

When playing a disc recorded with regular audio files (CD-DA or .WAV) and MP3/WMA files, the unit will play the MP3/WMA files only.

Only MP3 files with filename extension (.mp3) can be played.
Only WMA files with filename extension (.wma) can be played.

Do not attempt to play discs which contain non-MP3/WMA files with the MP3/WMA extension.

Sampling Frequency Rates

MP3 32kHz ~ 48kHz

WMA 32kHz ~ 48kHz

Transfer Bit rates

MP3 40kbps ~ 320kbps constant
Variable bit rates

WMA 40kbps ~ 192kbps constant
Variable bit rates

Note:

Some files may not play or be displayed correctly, depending on sampling rates and bit rates.

Recommended Settings

For best results, use the following settings when burning an MP3 disc:
128kbps or higher constant bit rate
44.1kHz or higher sampling frequency

For best results, use the following settings when burning a WMA disc:
64kbps or higher constant bit rate
44kHz or higher sampling frequency

Media Compatibility

Media Compatibility

The following types of discs/files are compatible:

- CD-ROM (ISO), CD-R, CD-RW, DVD+R/RW, DVD-R/RW
- CD-DA, DVD Video
- MP3 data
- WMA data

The following types of discs/files are not compatible:

- WMA files that are protected by DRM (Digital Rights Management)
- WMA lossless format
- Discs recorded with Track At Once or packet writing
- MP3 PRO format
- MP3 playlists
- WAV format
- WMV format
- JPG format
- DivX format
- AVI format
- MPG format

Some recordable DVDs and CDs may be incompatible with this unit, depending on media type and recording method.

Playback Order

MP3/WMA playback sequence is based on recorded order of files and begins in the root folder of the disc. Any empty folders or folders that do not include MP3/WMA files are skipped. This unit may not play files in the order they were recorded in. Refer to your recording software's user's manual for more information.

Compatible Recording Formats

- ISO9660 level 1
- ISO9660 level 2
- Yellow Book MODE 1
- Yellow Book MODE 2 FORM 1
- Multi session
- Maximum files - 1500
- Maximum folder levels - 8
- MPEG-1/2 Audio Layer-3

ISO9660 standards:

- Maximum nested folder depth is 8 (including the root folder).
- Valid characters for folder/file names are letters A-Z (all caps), numbers 0-9, and “_” (underscore). Some characters may not be displayed correctly, depending on the character type.
- This device can play back discs in Joliet and other standards that conform to ISO9660. MP3/WMA written in the formats other than the above may not play and/or their file names or folder names may not be displayed properly.



Troubleshooting

Problem	Cause	Action
Unit will not turn on (no power)	Yellow wire not connected or incorrect voltage Red wire not connected or incorrect voltage	Check connections for proper voltage (11~16VDC)
	Black wire not connected	Check connection to ground
	Fuse blown	Replace fuse
	Unit has power (but no sound)	Speaker wires not connected
	One or more speaker wires touching each other or touching chassis ground	Insulate all bare speaker wires from each other and chassis ground
Unit blows fuse	Yellow or red wire touching chassis ground	Check for pinched wire
	Speaker wires touching chassis ground	Check for pinched wire
	Incorrect fuse rating	Use fuse with correct rating
Unit has audio (but no video)	Parking brake safety circuit not connected Parking brake not applied	Check connections at parking brake Apply parking brake
No video display (when in reverse)	Reverse circuit not connected Vehicle is not in reverse Rear view set to OFF	Check connections at reverse lamp Select reverse gear Set rear view to ON - see page 14 for details
DVD does not start playback	Physical defect in media Wrong region	Check media for scratches Use discs labeled "Region 1" or "All" only.
IR remote does not work	Dead battery	Replace battery
Excessive skipping	Unit is not mounted correctly	Check mounting sleeve
	Physical defect in media	Check media for scratches
ERR-DISC appears on display	Focus error or disc is in upside down	Press eject or RESET
Region code error appears on display	Region code error	Use only DVDs labeled "Region 1" or "All" only.
Front panel will not open/close	Front panel obstructed	Remove the obstacle and press OPEN again to resume the monitor open/close sequence.

Limited One Year Warranty

This warranty gives you specific legal rights. You may also have other rights which vary from state to state.

Dual Electronics Corp. warrants this product to the original purchaser to be free from defects in material and workmanship for a period of one year from the date of the original purchase.

Dual Electronics Corp. agrees, at our option, during the warranty period, to repair any defect in material or workmanship or to furnish an equal new, renewed or comparable product (whichever is deemed necessary) in exchange without charges, subject to verification of the defect or malfunction and proof of the date of purchase. Subsequent replacement products are warranted for the balance of the original warranty period.

Who is covered? This warranty is extended to the original retail purchaser for products purchased and used in the U.S.A.

What is covered? This warranty covers all defects in material and workmanship in this product. The following are not covered: installation/removal costs, damage resulting from accident, misuse, abuse, neglect, product modification, improper installation, incorrect line voltage, unauthorized repair or failure to follow instructions supplied with the product, or damage occurring during return shipment of the product.

What to do?

1. Before you call for service, check the troubleshooting guide in your owner's manual. A slight adjustment of any custom controls may save you a service call.
2. If you require service during the warranty period, you must carefully pack the product (preferably in the original package) and ship it by prepaid transportation with a copy of the original receipt from the retailer to an authorized service center.
3. Please describe your problem in writing and include your name, a return UPS shipping address (P.O. Box not acceptable), and a daytime phone number with your shipment.
4. For more information and for the location of the nearest authorized service center please contact us by one of the following methods:
 - Call us toll-free at 1-866-382-5476
 - E-mail us at cs@dualav.com

Exclusion of Certain Damages: This warranty is exclusive and in lieu of any and all other warranties, expressed or implied, including without limitation the implied warranties of merchantability and fitness for a particular purpose and any obligation, liability, right, claim or remedy in contract or tort, whether or not arising from the company's negligence, actual or imputed. No person or representative is authorized to assume for the company any other liability in connection with the sale of this product. In no event shall the company be liable for indirect, incidental or consequential damages.

Specifications

DVD Player	Frequency response: 10Hz-20kHz Channel separation @ 1kHz: >65dB D/A converter: 24 Bit
FM Tuner	Tuning range: 87.5MHz-107.9MHz Usable sensitivity: 8.5dBf 50dB quieting sensitivity: 10dBf Stereo separation @ 1kHz: 40dB Frequency response: 30Hz-13kHz
AM Tuner	Tuning range: 530kHz-1720kHz Usable sensitivity: 22uV Frequency response: 30Hz-2.2kHz
Monitor	Panel size: 7" (177.8 mm) diagonal measurement View angle (up/down/left/right): 30/60/60/60 Resolution: 480 W x 234 H Brightness (cd/m ²): 350 Contrast ratio: 300:1 Elements: 336,960
General	Operating voltage: 11-16 VDC, negative ground Speaker output impedance: 4~8 ohms Line output voltage: 2 Volts Line output impedance: 200 ohms Chassis dimensions: 7" x 7" x 2" (178 x 178 x 51 mm)

Design and specifications subject to change without notice.



CEA-2006 Power Standard Specifications
(reference: 14.4VDC +/- 0.2V, 20Hz~20kHz)

Power Output: 17 Watts RMS x 4 channels at 4 ohms and $\leq 1\%$ THD+N
Signal to Noise Ratio: 80dBA (reference: 1 watt into 4 ohms)



XDVD8181

INSTALLATION/OWNER'S MANUAL

DVD Multimedia Receiver with 7" Touch Screen Display



Copyright Notes

This product incorporates copyright protection technology that is protected by method claims of certain U.S. patents and other intellectual property rights owned by Macrovision Corporation and other rights owners. Use of this copyright protection technology must be authorized by Macrovision Corporation, and is intended for home and other limited viewing uses only unless otherwise authorized by Macrovision Corporation. Reverse engineering or disassembly is prohibited.

Manufactured under license from Dolby Laboratories. "Dolby" and the double-D symbol are trademarks of Dolby Laboratories.

Windows Media and the Windows logo are trademarks, or registered trademarks of Microsoft Corporation in the United States and or other countries.

All other trademarks are property of their respective owners.



Dual Electronics Corp.
Toll Free: 1-866-382-5476

www.dualav.com

©2006 Dual Electronics Corp. All rights reserved.
NSA0906-V02

Printed in China